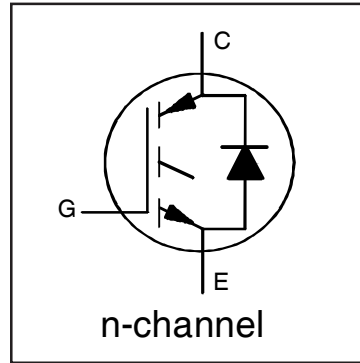


# IRGB4056DPbF

## INSULATED GATE BIPOLAR TRANSISTOR WITH ULTRAFAST SOFT RECOVERY DIODE

### Features

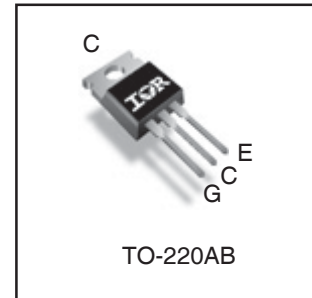
- Low  $V_{CE(ON)}$  Trench IGBT Technology
- Low switching losses
- Maximum Junction temperature 175 °C
- 5  $\mu$ S short circuit SOA
- Square RBSOA
- 100% of the parts tested for 4X rated current ( $I_{LM}$ )
- Positive  $V_{CE(ON)}$  Temperature co-efficient
- Ultra fast soft Recovery Co-Pak Diode
- Tight parameter distribution
- Lead Free Package



$V_{CES} = 600V$
$I_C = 12A, T_C = 100^\circ C$
$t_{SC} \geq 5\mu s, T_{J(max)} = 175^\circ C$
$V_{CE(on)} \text{ typ.} = 1.55V$

### Benefits

- High Efficiency in a wide range of applications
- Suitable for a wide range of switching frequencies due to Low  $V_{CE(ON)}$  and Low Switching losses
- Rugged transient Performance for increased reliability
- Excellent Current sharing in parallel operation
- Low EMI



<b>G</b>	<b>C</b>	<b>E</b>
Gate	Collector	Emitter

### Absolute Maximum Ratings

	Parameter	Max.	Units
$V_{CES}$	Collector-to-Emitter Voltage	600	V
$I_C @ T_C = 25^\circ C$	Continuous Collector Current	24	A
$I_C @ T_C = 100^\circ C$	Continuous Collector Current	12	
$I_{CM}$	Pulse Collector Current	48	
$I_{LM}$	Clamped Inductive Load Current $\text{\textcircled{D}}$	48	
$I_F @ T_C = 25^\circ C$	Diode Continuous Forward Current	24	
$I_F @ T_C = 100^\circ C$	Diode Continuous Forward Current	12	
$I_{FM}$	Diode Maximum Forward Current $\text{\textcircled{D}}$	48	
$V_{GE}$	Continuous Gate-to-Emitter Voltage	$\pm 20$	V
	Transient Gate-to-Emitter Voltage	$\pm 30$	
$P_D @ T_C = 25^\circ C$	Maximum Power Dissipation	140	W
		$P_D @ T_C = 100^\circ C$	
$T_J$	Operating Junction and	-55 to +175	°C
$T_{STG}$	Storage Temperature Range		
	Soldering Temperature, for 10 sec.	300 (0.063 in. (1.6mm) from case)	
	Mounting Torque, 6-32 or M3 Screw	10 lbf-in (1.1 N-m)	

### Thermal Resistance

	Parameter	Min.	Typ.	Max.	Units
$R_{\theta JC}$ (IGBT)	Thermal Resistance Junction-to-Case-(each IGBT)	—	—	1.07	°C/W
$R_{\theta JC}$ (Diode)	Thermal Resistance Junction-to-Case-(each Diode)	—	—	3.66	
$R_{\theta CS}$	Thermal Resistance, Case-to-Sink (flat, greased surface)	—	0.50	—	
$R_{\theta JA}$	Thermal Resistance, Junction-to-Ambient (typical socket mount)	—	80	—	

### Electrical Characteristics @ $T_J = 25^\circ\text{C}$ (unless otherwise specified)

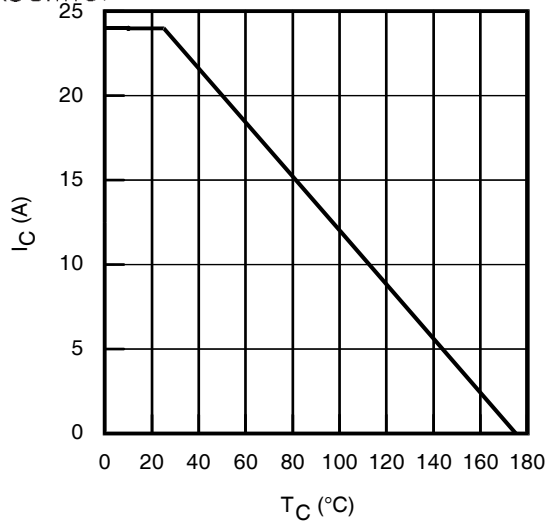
	Parameter	Min.	Typ.	Max.	Units	Conditions	Ref.Fig
$V_{(BR)CES}$	Collector-to-Emitter Breakdown Voltage	600	—	—	V	$V_{GE} = 0V, I_C = 100\mu A$ ④	CT6
$\Delta V_{(BR)CES}/\Delta T_J$	Temperature Coeff. of Breakdown Voltage	—	0.30	—	V/ $^\circ\text{C}$	$V_{GE} = 0V, I_C = 1mA$ (25 $^\circ\text{C}$ -175 $^\circ\text{C}$ )	CT6
$V_{CE(on)}$	Collector-to-Emitter Saturation Voltage	—	1.55	1.85	V	$I_C = 12A, V_{GE} = 15V, T_J = 25^\circ\text{C}$	5,6,7
		—	1.90	—		$I_C = 12A, V_{GE} = 15V, T_J = 150^\circ\text{C}$	9,10,11
		—	1.97	—		$I_C = 12A, V_{GE} = 15V, T_J = 175^\circ\text{C}$	
$V_{GE(th)}$	Gate Threshold Voltage	4.0	—	6.5	V	$V_{CE} = V_{GE}, I_C = 350\mu A$	9, 10,
$\Delta V_{GE(th)}/\Delta T_J$	Threshold Voltage temp. coefficient	—	-18	—	mV/ $^\circ\text{C}$	$V_{CE} = V_{GE}, I_C = 1.0mA$ (25 $^\circ\text{C}$ - 175 $^\circ\text{C}$ )	11, 12
$g_{fe}$	Forward Transconductance	—	7.7	—	S	$V_{CE} = 50V, I_C = 12A, PW = 80\mu s$	
$I_{CES}$	Collector-to-Emitter Leakage Current	—	2.0	25	$\mu A$	$V_{GE} = 0V, V_{CE} = 600V$	
		—	475	—		$V_{GE} = 0V, V_{CE} = 600V, T_J = 175^\circ\text{C}$	
$V_{FM}$	Diode Forward Voltage Drop	—	2.10	3.10	V	$I_F = 12A$	8
		—	1.61	—		$I_F = 12A, T_J = 175^\circ\text{C}$	
$I_{GES}$	Gate-to-Emitter Leakage Current	—	—	$\pm 100$	nA	$V_{GE} = \pm 20V$	

### Switching Characteristics @ $T_J = 25^\circ\text{C}$ (unless otherwise specified)

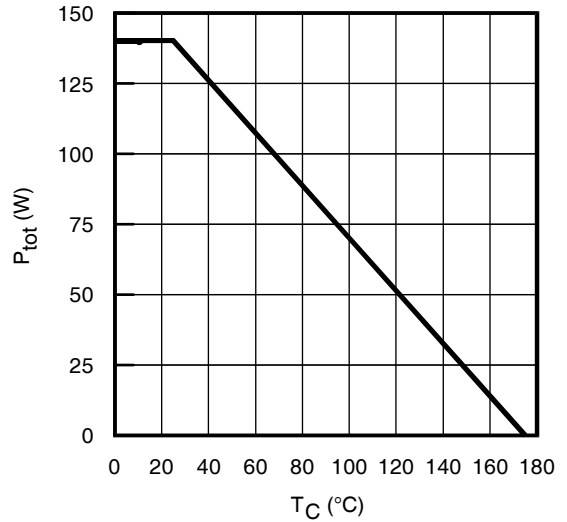
	Parameter	Min.	Typ.	Max.	Units	Conditions	Ref.Fig
$Q_g$	Total Gate Charge (turn-on)	—	25	38	nC	$I_C = 12A$ $V_{GE} = 15V$ $V_{CC} = 400V$	24
$Q_{ge}$	Gate-to-Emitter Charge (turn-on)	—	7.0	11			CT1
$Q_{gc}$	Gate-to-Collector Charge (turn-on)	—	11	16			
$E_{on}$	Turn-On Switching Loss	—	75	118	$\mu J$	$I_C = 12A, V_{CC} = 400V, V_{GE} = 15V$ $R_G = 22\Omega, L = 200\mu H, L_S = 150nH, T_J = 25^\circ\text{C}$ Energy losses include tail & diode reverse recovery	CT4
$E_{off}$	Turn-Off Switching Loss	—	225	273			
$E_{total}$	Total Switching Loss	—	300	391			
$t_{d(on)}$	Turn-On delay time	—	31	40	ns	$I_C = 12A, V_{CC} = 400V, V_{GE} = 15V$ $R_G = 22\Omega, L = 200\mu H, L_S = 150nH, T_J = 25^\circ\text{C}$	CT4
$t_r$	Rise time	—	17	24			
$t_{d(off)}$	Turn-Off delay time	—	83	94			
$t_f$	Fall time	—	24	31			
$E_{on}$	Turn-On Switching Loss	—	185	—	$\mu J$	$I_C = 12A, V_{CC} = 400V, V_{GE} = 15V$ $R_G = 22\Omega, L = 100\mu H, L_S = 150nH, T_J = 175^\circ\text{C}$ ④ Energy losses include tail & diode reverse recovery	13, 15
$E_{off}$	Turn-Off Switching Loss	—	355	—			CT4
$E_{total}$	Total Switching Loss	—	540	—			WF1, WF2
$t_{d(on)}$	Turn-On delay time	—	30	—	ns	$I_C = 12A, V_{CC} = 400V, V_{GE} = 15V$ $R_G = 22\Omega, L = 200\mu H, L_S = 150nH$ $T_J = 175^\circ\text{C}$	14, 16
$t_r$	Rise time	—	18	—			CT4
$t_{d(off)}$	Turn-Off delay time	—	102	—			WF1
$t_f$	Fall time	—	41	—			WF2
$C_{ies}$	Input Capacitance	—	765	—	pF	$V_{GE} = 0V$ $V_{CC} = 30V$ $f = 1.0Mhz$	23
$C_{oes}$	Output Capacitance	—	52	—			
$C_{res}$	Reverse Transfer Capacitance	—	23	—			
RBSOA	Reverse Bias Safe Operating Area	FULL SQUARE				$T_J = 175^\circ\text{C}, I_C = 48A$ $V_{CC} = 480V, V_p = 600V$ $R_G = 22\Omega, V_{GE} = +15V$ to 0V	4 CT2
SCSOA	Short Circuit Safe Operating Area	5	—	—	$\mu s$	$V_{CC} = 400V, V_p = 600V$ $R_G = 22\Omega, V_{GE} = +15V$ to 0V	22, CT3 WF4
$E_{rec}$	Reverse Recovery Energy of the Diode	—	280	—	$\mu J$	$T_J = 175^\circ\text{C}$	17, 18, 19
$t_{rr}$	Diode Reverse Recovery Time	—	68	—	ns	$V_{CC} = 400V, I_F = 12A$	20, 21
$I_{rr}$	Peak Reverse Recovery Current	—	19	—	A	$V_{GE} = 15V, R_G = 22\Omega, L = 200\mu H, L_S = 150nH$	WF3

#### Notes:

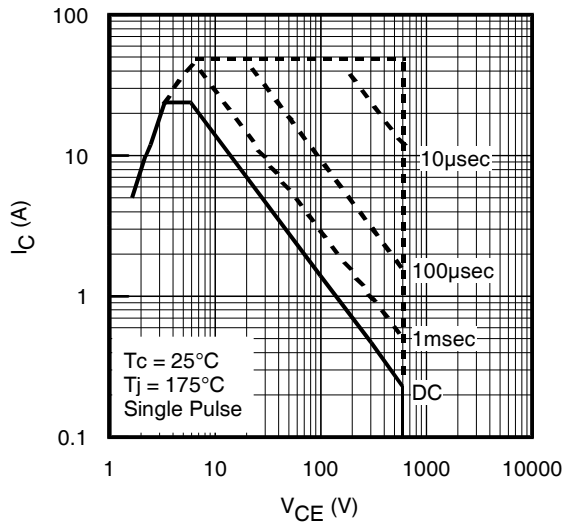
- ①  $V_{CC} = 80\% (V_{CES}), V_{GE} = 20V, L = 100\mu H, R_G = 22\Omega$ .
- ② This is only applied to TO-220AB package.
- ③ Pulse width limited by max. junction temperature.
- ④ Refer to AN-1086 for guidelines for measuring  $V_{(BR)CES}$  safely.



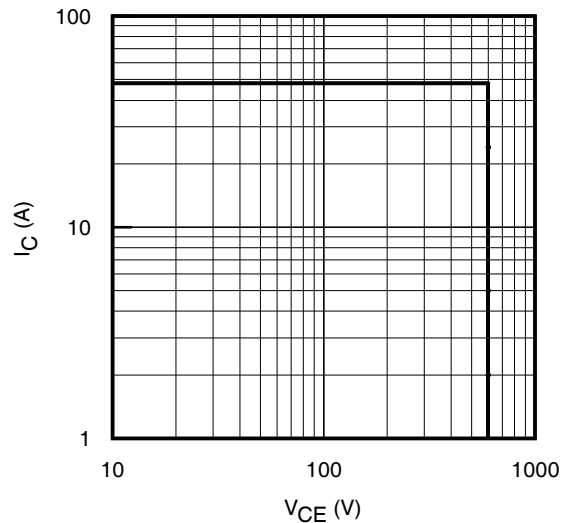
**Fig. 1** - Maximum DC Collector Current vs. Case Temperature



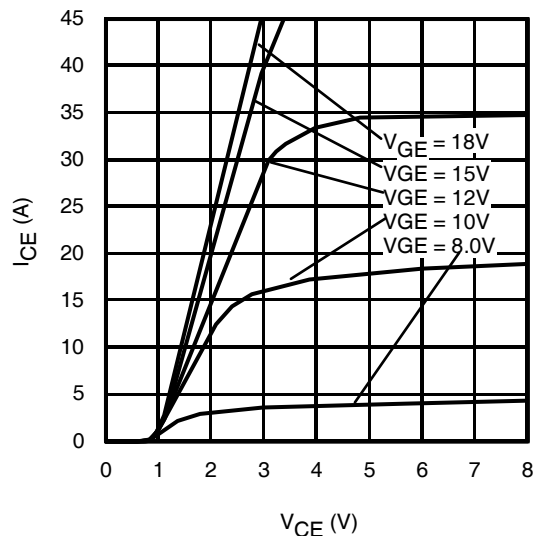
**Fig. 2** - Power Dissipation vs. Case Temperature



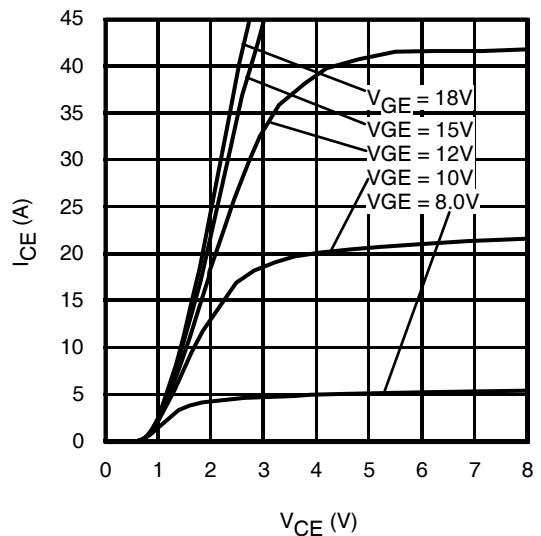
**Fig. 3** - Forward SOA  
 $T_C = 25^\circ\text{C}$ ,  $T_J \leq 175^\circ\text{C}$ ;  $V_{GE} = 15\text{V}$



**Fig. 4** - Reverse Bias SOA  
 $T_J = 175^\circ\text{C}$ ;  $V_{GE} = 15\text{V}$

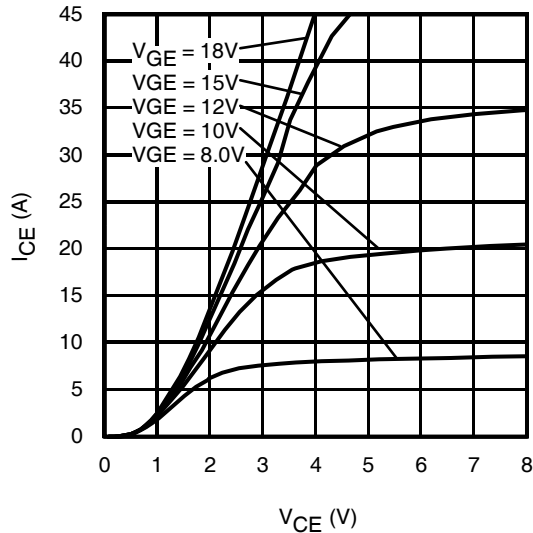


**Fig. 5** - Typ. IGBT Output Characteristics  
 $T_J = -40^\circ\text{C}$ ;  $t_p = 80\mu\text{s}$

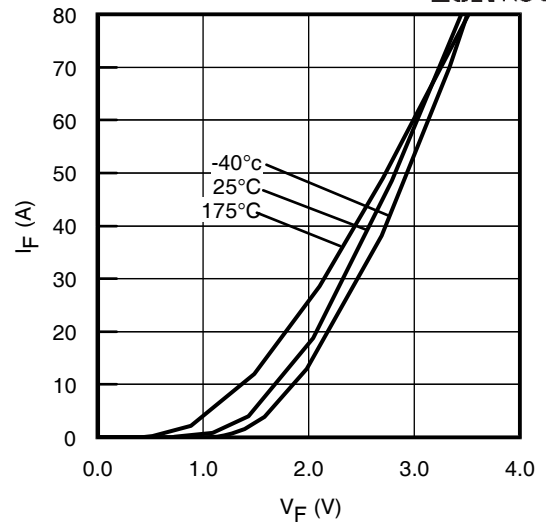


**Fig. 6** - Typ. IGBT Output Characteristics  
 $T_J = 25^\circ\text{C}$ ;  $t_p = 80\mu\text{s}$

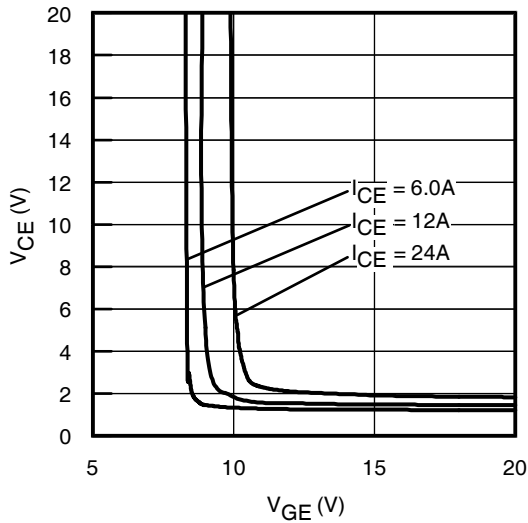
# IRGB4056DPbF



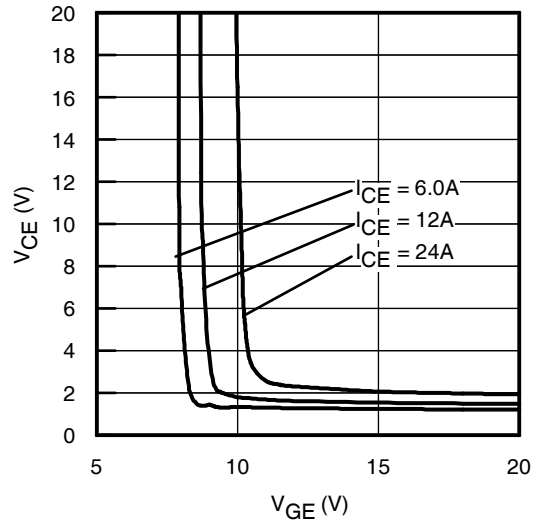
**Fig. 7** - Typ. IGBT Output Characteristics  
 $T_J = 175^\circ\text{C}$ ;  $t_p = 80\mu\text{s}$



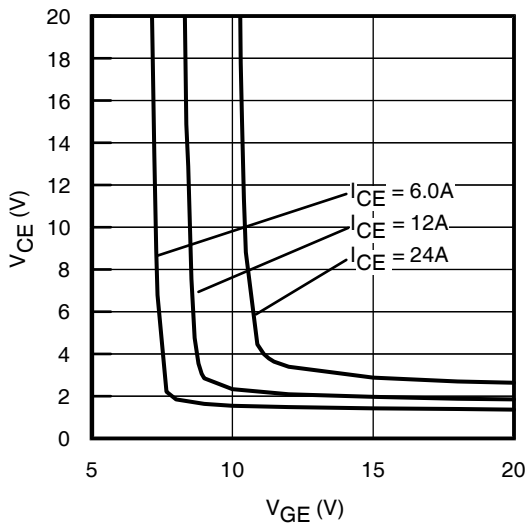
**Fig. 8** - Typ. Diode Forward Characteristics  
 $t_p = 80\mu\text{s}$



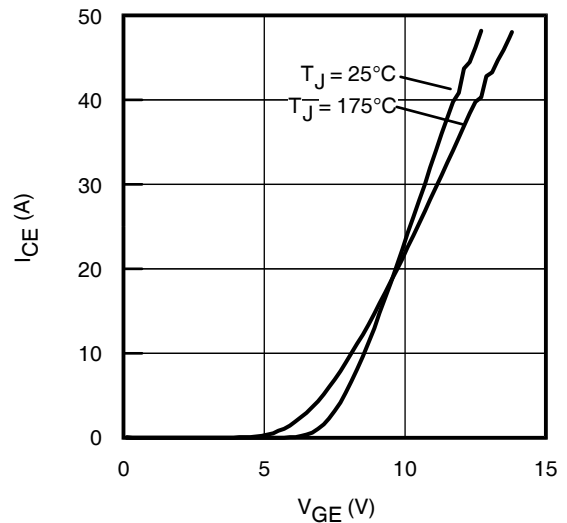
**Fig. 9** - Typical  $V_{CE}$  vs.  $V_{GE}$   
 $T_J = -40^\circ\text{C}$



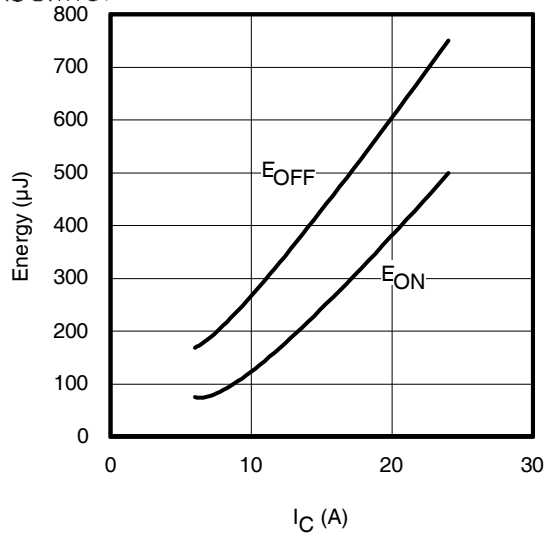
**Fig. 10** - Typical  $V_{CE}$  vs.  $V_{GE}$   
 $T_J = 25^\circ\text{C}$



**Fig. 11** - Typical  $V_{CE}$  vs.  $V_{GE}$   
 $T_J = 175^\circ\text{C}$

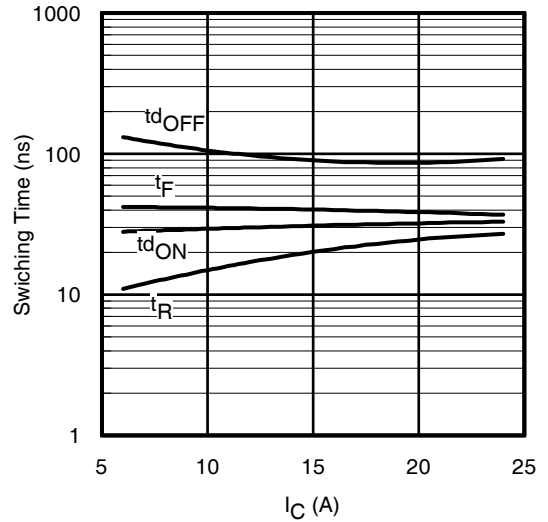


**Fig. 12** - Typ. Transfer Characteristics  
 $V_{CE} = 50\text{V}$ ;  $t_p = 10\mu\text{s}$



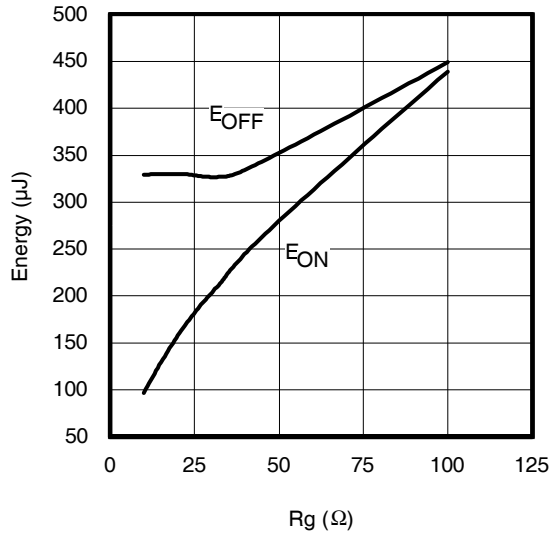
**Fig. 13** - Typ. Energy Loss vs.  $I_C$

$T_J = 175^\circ\text{C}$ ;  $L = 200\mu\text{H}$ ;  $V_{CE} = 400\text{V}$ ,  $R_G = 22\Omega$ ;  $V_{GE} = 15\text{V}$



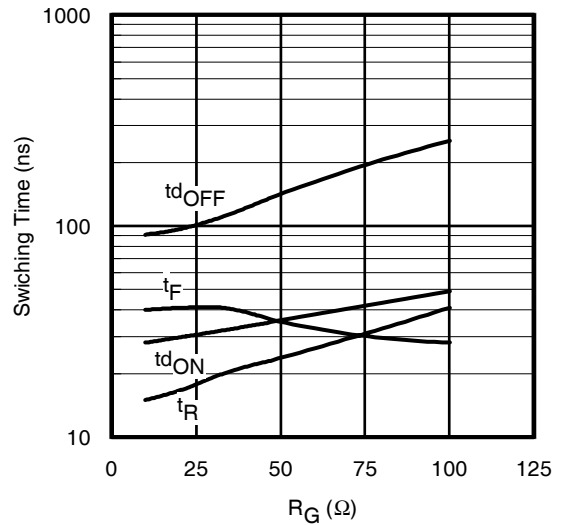
**Fig. 14** - Typ. Switching Time vs.  $I_C$

$T_J = 175^\circ\text{C}$ ;  $L = 200\mu\text{H}$ ;  $V_{CE} = 400\text{V}$ ,  $R_G = 22\Omega$ ;  $V_{GE} = 15\text{V}$



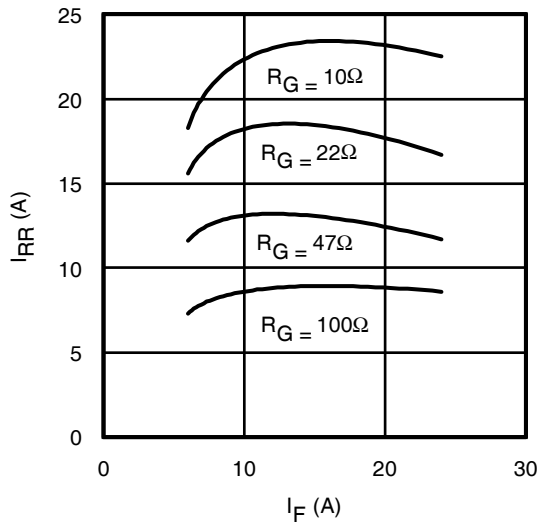
**Fig. 15** - Typ. Energy Loss vs.  $R_G$

$T_J = 175^\circ\text{C}$ ;  $L = 200\mu\text{H}$ ;  $V_{CE} = 400\text{V}$ ,  $I_{CE} = 12\text{A}$ ;  $V_{GE} = 15\text{V}$



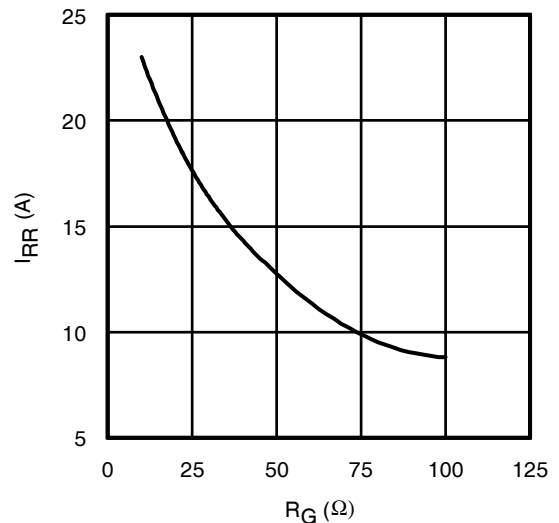
**Fig. 16** - Typ. Switching Time vs.  $R_G$

$T_J = 175^\circ\text{C}$ ;  $L = 200\mu\text{H}$ ;  $V_{CE} = 400\text{V}$ ,  $I_{CE} = 12\text{A}$ ;  $V_{GE} = 15\text{V}$



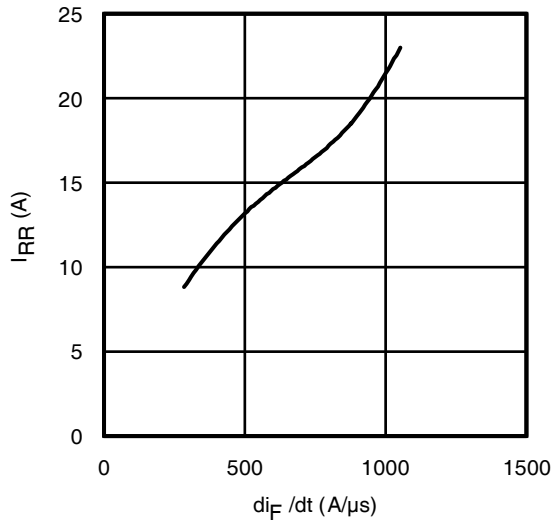
**Fig. 17** - Typ. Diode  $I_{RR}$  vs.  $I_F$

$T_J = 175^\circ\text{C}$

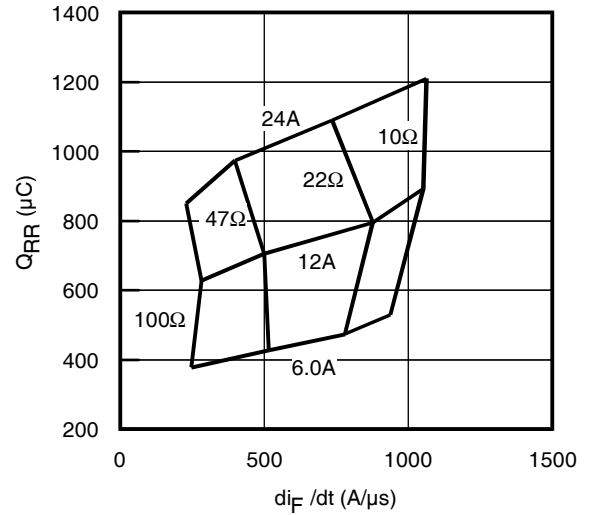


**Fig. 18** - Typ. Diode  $I_{RR}$  vs.  $R_G$

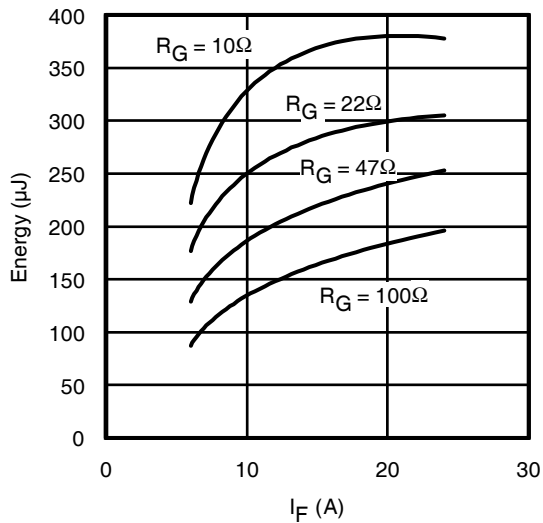
$T_J = 175^\circ\text{C}$



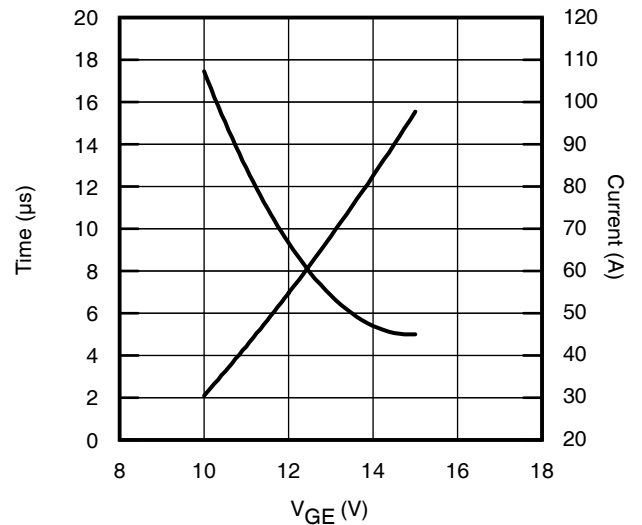
**Fig. 19** - Typ. Diode  $I_{RR}$  vs.  $di_F/dt$   
 $V_{CC} = 400V$ ;  $V_{GE} = 15V$ ;  $I_F = 12A$ ;  $T_J = 175^\circ C$



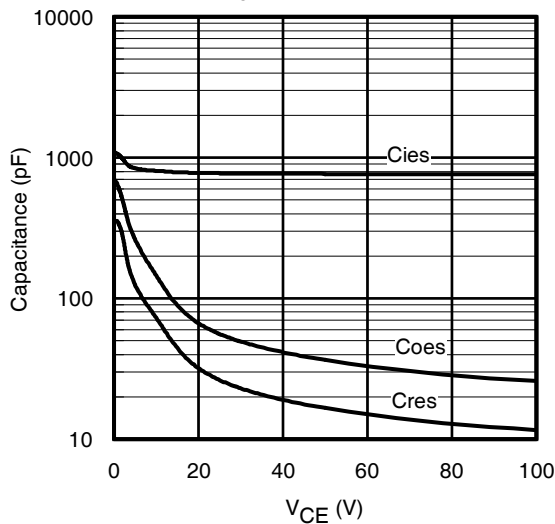
**Fig. 20** - Typ. Diode  $Q_{RR}$  vs.  $di_F/dt$   
 $V_{CC} = 400V$ ;  $V_{GE} = 15V$ ;  $T_J = 175^\circ C$



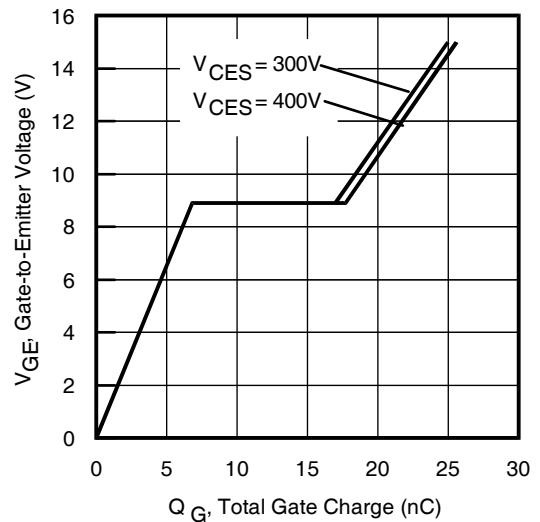
**Fig. 21** - Typ. Diode  $E_{RR}$  vs.  $I_F$   
 $T_J = 175^\circ C$



**Fig. 22** -  $V_{GE}$  vs. Short Circuit Time  
 $V_{CC} = 400V$ ;  $T_C = 25^\circ C$



**Fig. 23** - Typ. Capacitance vs.  $V_{CE}$   
 $V_{GE} = 0V$ ;  $f = 1MHz$



**Fig. 24** - Typical Gate Charge vs.  $V_{GE}$   
 $I_{CE} = 12A$ ;  $L = 600\mu H$

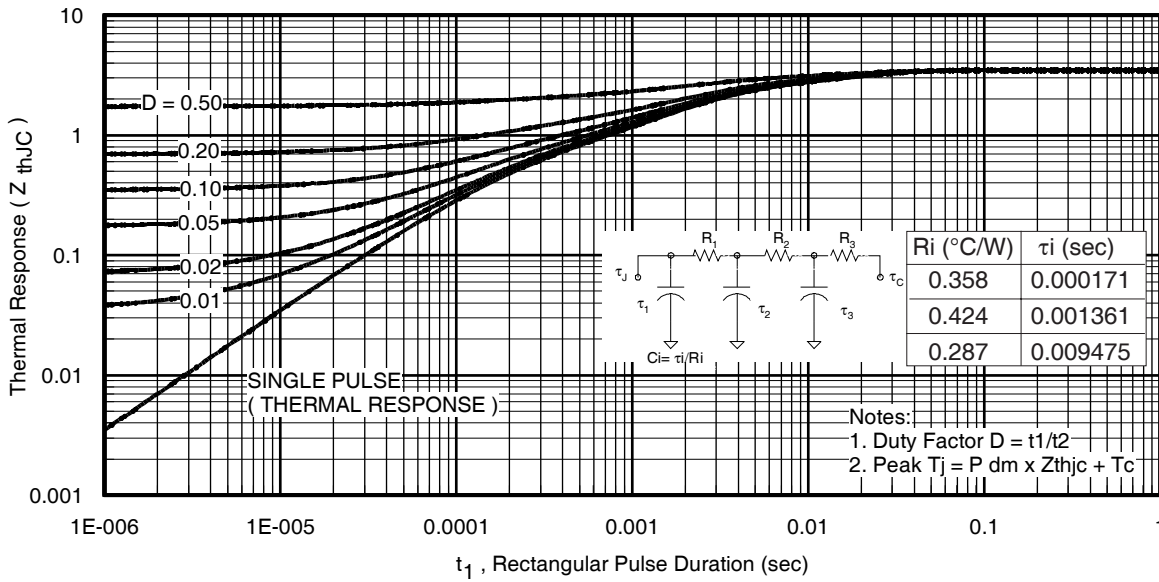


Fig 25. Maximum Transient Thermal Impedance, Junction-to-Case (IGBT)

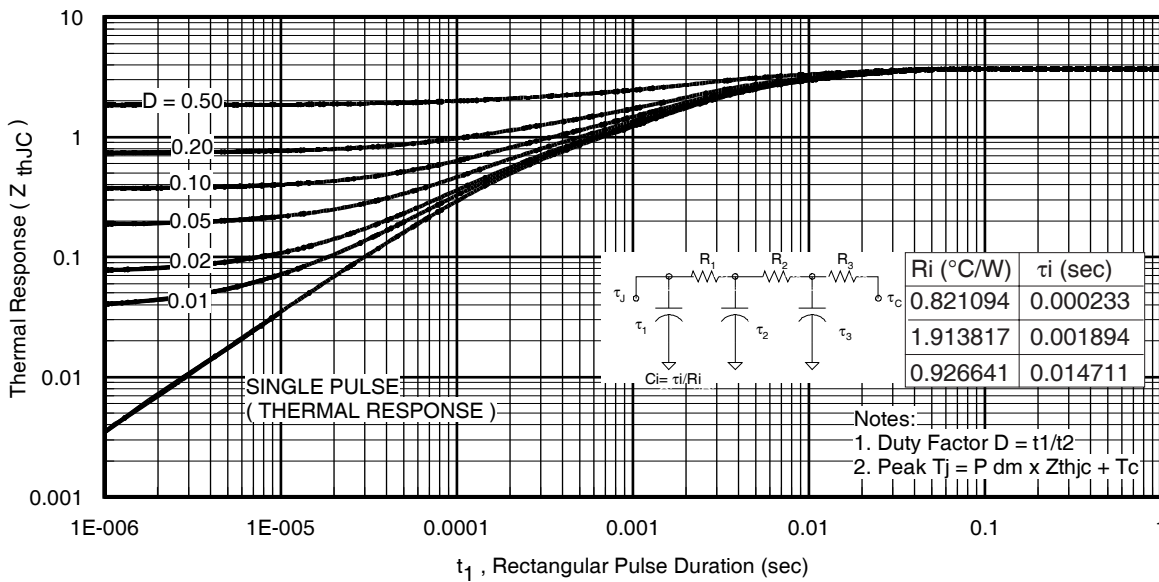
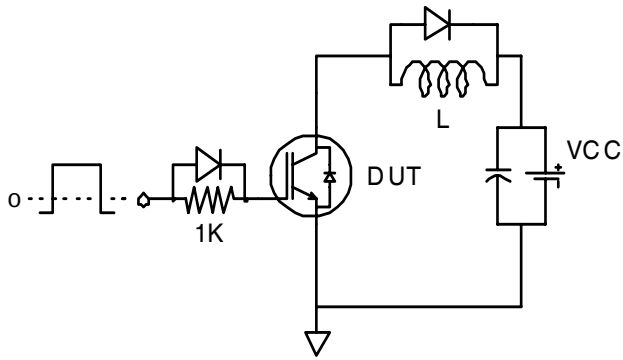
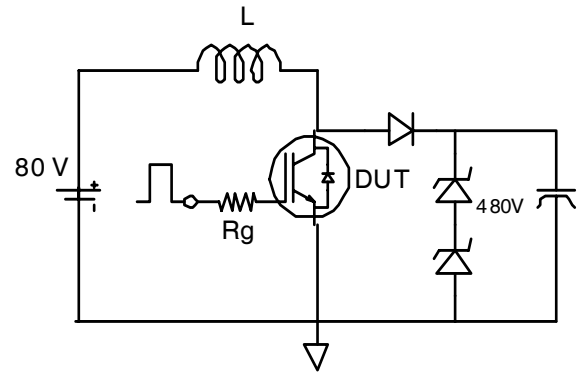


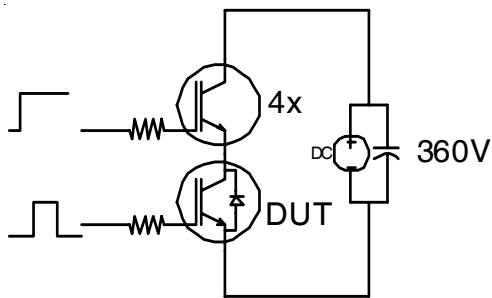
Fig. 26. Maximum Transient Thermal Impedance, Junction-to-Case (DIODE)



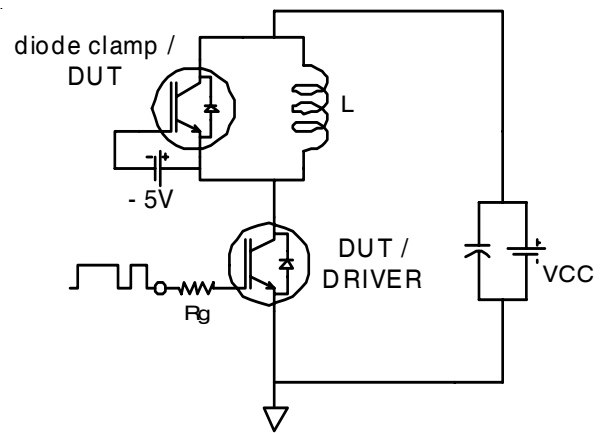
**Fig.C.T.1** - Gate Charge Circuit (turn-off)



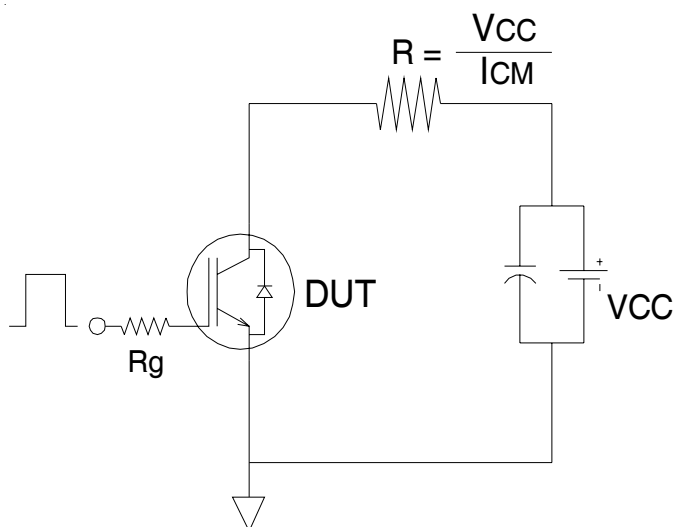
**Fig.C.T.2** - RBSOA Circuit



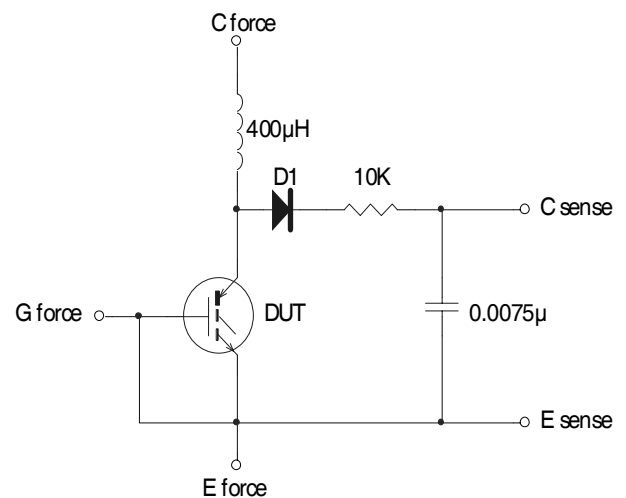
**Fig.C.T.3** - S.C. SOA Circuit



**Fig.C.T.4** - Switching Loss Circuit

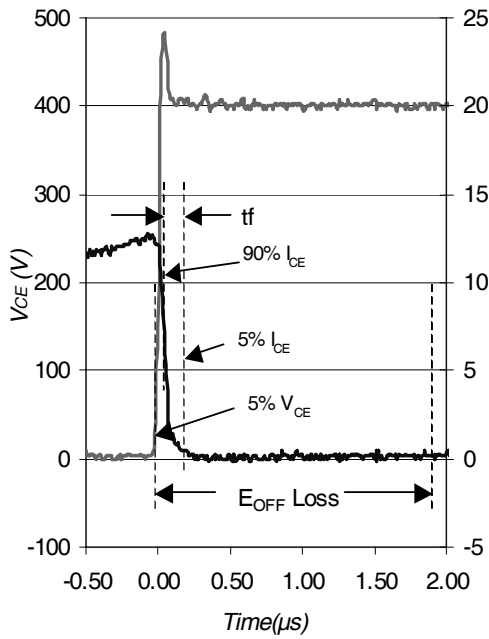


**Fig.C.T.5** - Resistive Load Circuit

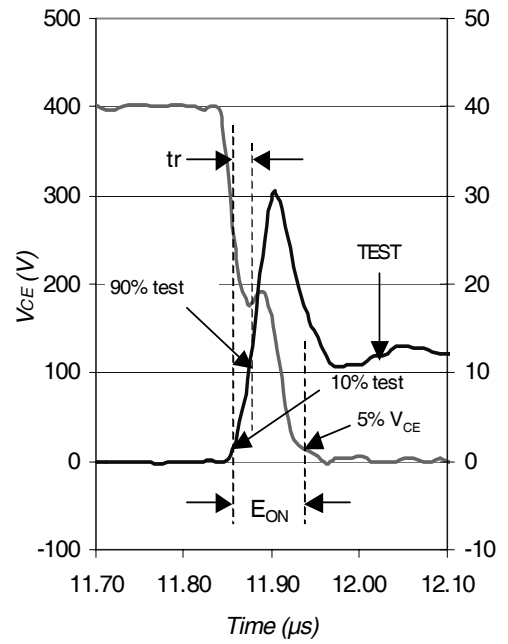


**Fig.C.T.6** - BV CES Filter Circuit

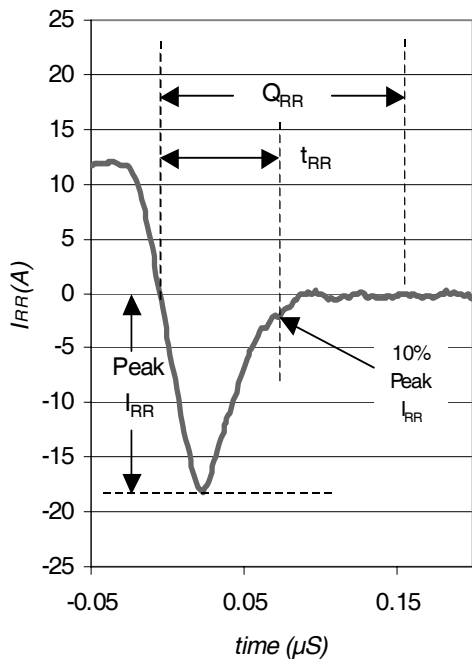




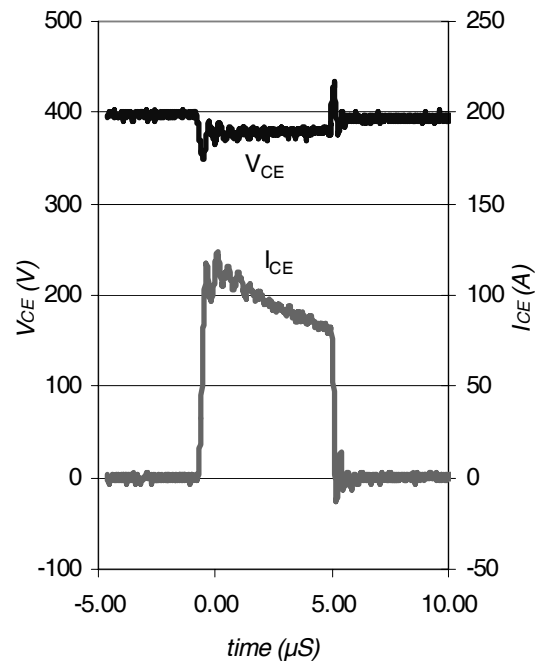
**Fig. WF1** - Typ. Turn-off Loss Waveform  
@  $T_J = 175^\circ\text{C}$  using Fig. CT.4



**Fig. WF2** - Typ. Turn-on Loss Waveform  
@  $T_J = 175^\circ\text{C}$  using Fig. CT.4



**Fig. WF3** - Typ. Diode Recovery Waveform  
@  $T_J = 175^\circ\text{C}$  using Fig. CT.4

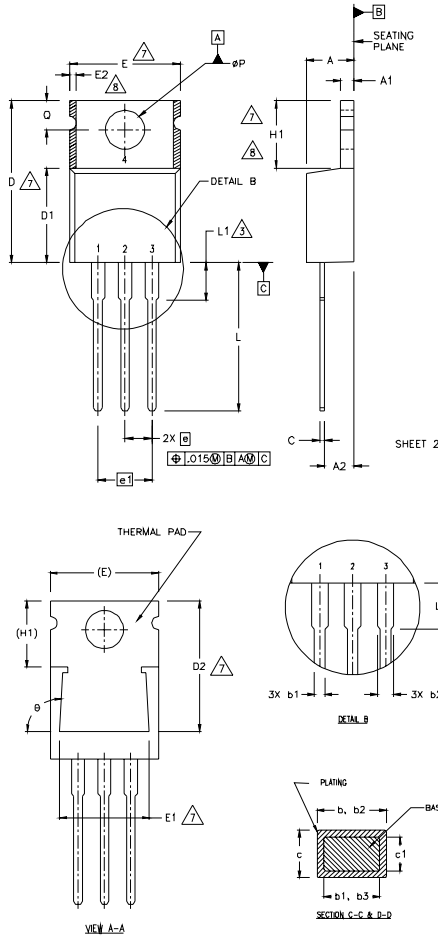


**Fig. WF4** - Typ. S.C. Waveform  
@  $T_J = 25^\circ\text{C}$  using Fig. CT.3

# IRGB4056DPbF

## TO-220AB Package Outline

Dimensions are shown in millimeters (inches)



- NOTES:
- 1 DIMENSIONING AND TOLERANCING PER ASME Y14.5 M- 1994.
  - 2 DIMENSIONS ARE SHOWN IN INCHES [MILLIMETERS].
  - 3 LEAD DIMENSION AND FINISH UNCONTROLLED IN L1.
  - 4 DIMENSION D & E DO NOT INCLUDE MOLD FLASH. MOLD FLASH SHALL NOT EXCEED .005" (0.127) PER SIDE. THESE DIMENSIONS ARE MEASURED AT THE OUTERMOST EXTREMES OF THE PLASTIC BODY.
  - 5 DIMENSION b1 & c1 APPLY TO BASE METAL ONLY.
  - 6 CONTROLLING DIMENSION - INCHES.
  - 7 THERMAL PAD CONTOUR OPTIONAL WITHIN DIMENSIONS E,H1,D2 & E1
  - 8 DIMENSION E2 X H1 DEFINE A ZONE WHERE STAMPING AND SINGULATION IRREGULARITIES ARE ALLOWED.

LEAD ASSIGNMENTS

HEXLET

- 1- GATE
- 2- DRAIN
- 3- SOURCE

IGBTs, GCRPACK

- 1- GATE
- 2- COLLECTOR
- 3- EMITTER

DODES

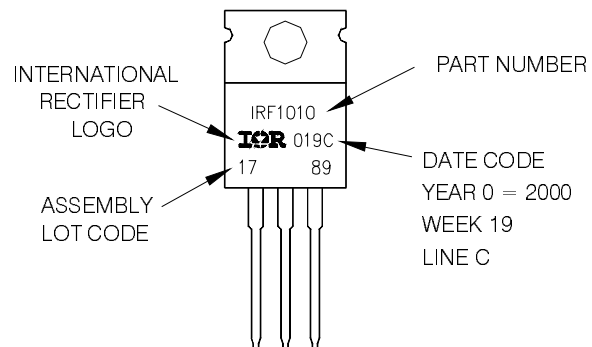
- 1- ANODE/OPEN
- 2- CATHODE
- 3- ANODE

SYMBOL	DIMENSIONS				NOTES
	MILLIMETERS		INCHES		
	MIN.	MAX.	MIN.	MAX.	
A	3.56	4.82	.140	.190	
A1	0.51	1.40	.020	.055	
A2	2.04	2.92	.080	.115	
b	0.38	1.01	.015	.040	
b1	0.38	0.96	.015	.038	5
b2	1.15	1.77	.045	.070	
b3	1.15	1.73	.045	.068	
c	0.36	0.61	.014	.024	
c1	0.36	0.56	.014	.022	5
D	14.22	16.51	.560	.650	4
D1	8.38	9.02	.330	.355	
D2	12.19	12.88	.480	.507	7
E	9.66	10.66	.380	.420	4,7
E1	8.38	8.89	.330	.350	7
e	2.54 BSC		.100 BSC		
e1	5.08		.200 BSC		
H1	5.85	6.55	.230	.270	7,8
L	12.70	14.73	.500	.580	
L1	-	6.35	-	.250	3
øP	3.54	4.08	.139	.161	
Q	2.54	3.42	.100	.135	
ø	90°-93°		90°-93°		

## TO-220AB Part Marking Information

EXAMPLE: THIS IS AN IRF1010  
LOT CODE 1789  
ASSEMBLED ON WW 19, 2000  
IN THE ASSEMBLY LINE "C"

Note: "P" in assembly line position indicates "Lead - Free"



**TO-220AB package is not recommended for Surface Mount Application.**

Data and specifications subject to change without notice.  
This product has been designed and qualified for Industrial market.  
Qualification Standards can be found on IR's Web site.